

DUCATI vérin model **EVO 700T** schéma d'installation

- EVO700T
- EVO700T FC (Version FC = avec arrêt mécanique intégré dans le vérin pour position tube télescopique en dedans= position portail ouvert si ouverture vers l'intérieur)

Limites d'utilisation:

longueur maximale du vantail: maxi 5m
 poids maximum du vantail: maxi 350kg

Dimensions Vérin:

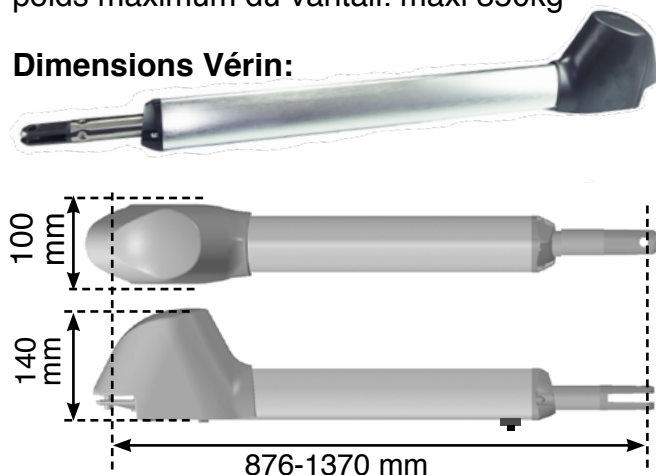

Plaques de fixation multiposition

Plaque arrière

Plaque avant

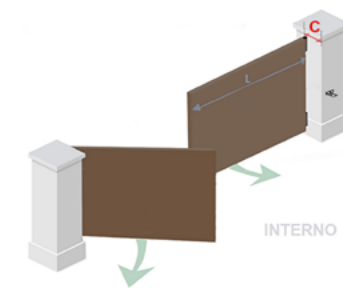
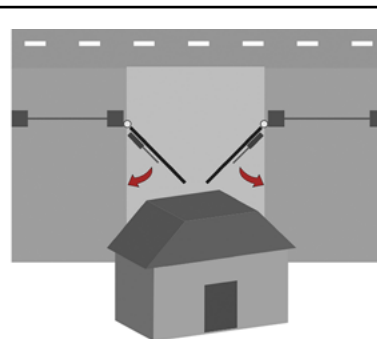
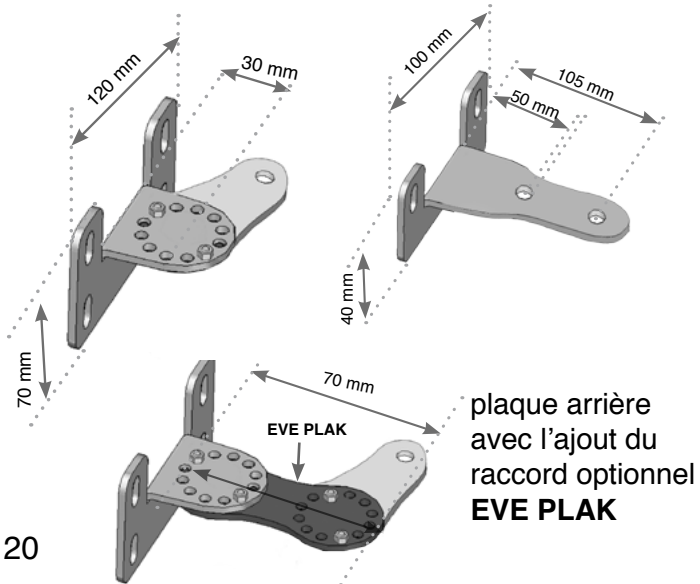

Si le portail s'ouvre vers l'intérieur de la propriété (voire page.9)

Respecter les limites de mesure A et B du tableau ci-dessous

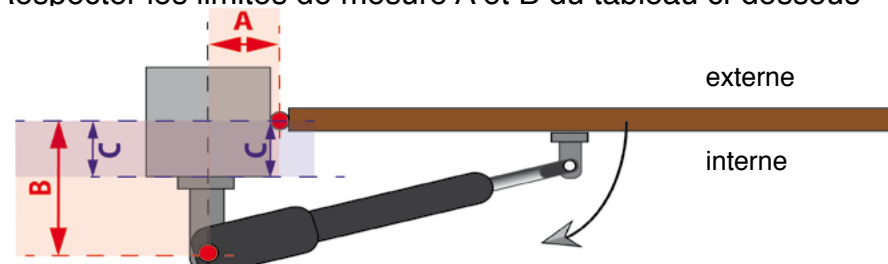

TAB	A-9	A-11	A-13	A-15	A-17	A-19	A-21	A-23	A-25
B-9	105°21sec	115°22sec	120°23sec	120°23sec	125°23sec	130°25sec	135°26sec	135°26sec	120°23sec
B-11	105°21sec	115°22sec	115°22sec	115°22sec	120°23sec	125°23sec	130°25sec	90°18sec	115°22sec
B-13	100°20sec	105°21sec	110°21sec	115°22sec	115°22sec	120°23sec	125°23sec	125°23sec	105°21sec
B-15	105°17sec	105°19sec	110°21sec	115°23sec	120°26sec	125°28sec	125°30sec	125°23sec	105°21sec
B-18	100°18sec	105°20sec	110°23sec	115°25sec	115°27sec	120°29sec	100°28sec	105°21sec	100°20sec
B-21	105°20sec	100°22sec	105°24sec	110°26sec	110°28sec				
B-25	95°23sec	100°25sec	105°27sec	110°29sec	110°31sec				
B-29	95°27sec	100°28sec	100°30sec	105°32sec					
B-33	95°30sec	95°32sec	90°32sec						
B-35	95°32sec	95°33sec							

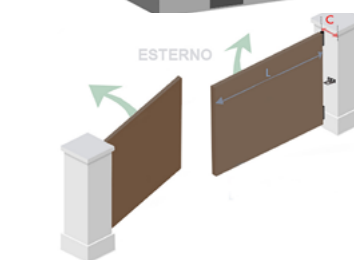
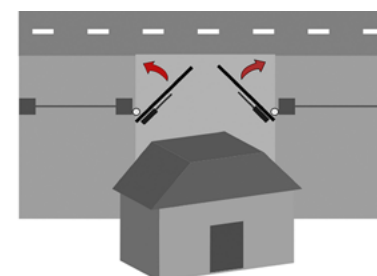

Installation sur portail ouvrant vers l'extérieur (voire page 9)

Respecter les limites de mesure A et B du tableau ci-dessous

A = min. 8 cm

B = max 14 cm

