

# DUCATI HC612 actuator's installation diagram

- HC612
  - HC612 FC (with on board open position mechanical limit)
- each model is also available in 24V version



### Maximal wing dimension:

Maximal wing lenght: up to 5m/ 16 ft  
 Maximal wing weight: up to 500kg/ 110lb

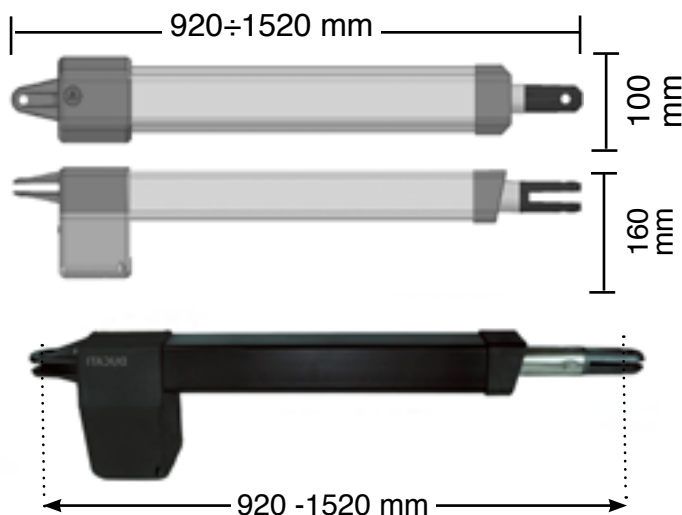

### Supplied fixing bracket:

choose the hole most suitable to your gate. you can cut the plate if necessary

#### Post fixing

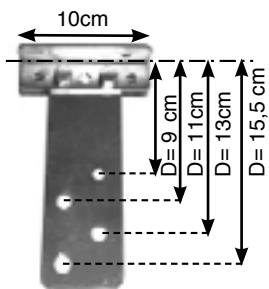

#### Front fixing

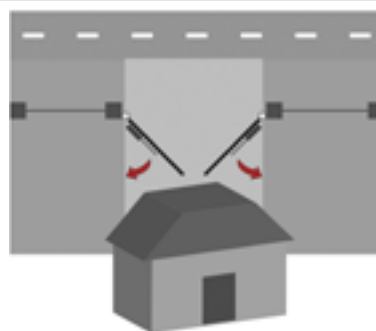
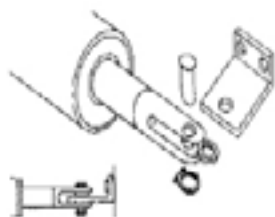

### PULL TO OPEN OPERATION ( opens towards inside)

This means the gate operator is mounted on the inside of the property and pulls your gate in towards the property to open.

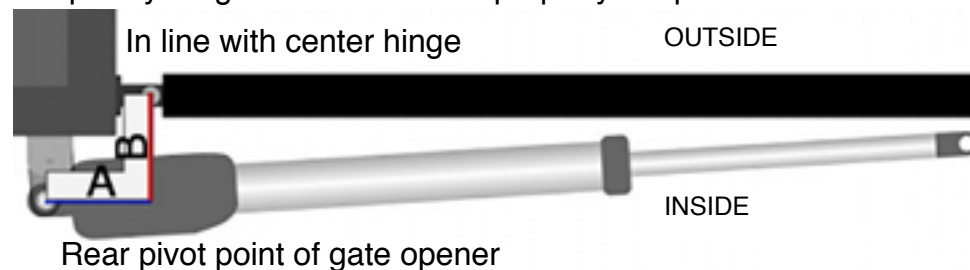

### METRIC CONVERSION

1 cm = 1/2" = 0,3"  
 10 cm = 4"  
 12 cm = 4 3/4" = 4,7"  
 14 cm = 5 1/2" = 5,5"  
 16 cm = 6 1/5" = 6,2"  
 18 cm = 7"  
 20 cm = 7 7/8" = 7,87"  
 25 cm = 9 3/4" = 9,8"  
 35cm = 13 4/5" = 13,7"

TAB	A= 8cm	A= 10cm	A= 12cm	A= 14cm	A= 16 cm	A= 18cm	A= 20cm	A= 22cm	A= 24cm	A= 26cm	A= 28cm
B= 8cm	16 sec/97°	18sec/110°	21sec/118°	23sec/125°	23sec/130°	24sec/135°	26sec/137°	27sec/115°	31sec/108°	32sec/103°	32sec/105°
B= 10cm	18sec/98°	19sec/107°	22sec/114°	23sec/121°	25sec/127°	27sec/131°	27sec/125°	29sec/115°	31sec/108°	32sec/103°	33sec/99°
B= 12cm	20sec/98°	23sec/105°	24sec/112°	26sec/118°	27sec/124°	29sec/127°	30sec/120°	33sec/110°	34sec/104°	35sec/100°	369sec/96°
B= 14cm	21sec/95°	24sec/103°	25sec/108°	27sec/105°	28sec/120°	30sec/125°	32sec/111°	33sec/105°	35sec/99°	36sec/95°	37sec/93°
B= 16cm	23sec/94°	25sec/102°	28sec/108°	30sec/103°	31sec/118°	33sec/113°	34sec/102°	35sec/98°	37sec/94°	38sec/90°	
B= 18cm	26sec/94°	27sec/100°	29sec/106°	32sec/111°	33sec/115°	34sec/105°	36sec/97°	36sec/93°	38sec/90°		
B= 20cm	28sec/94°	30sec/100°	32sec/105°	34sec/109°	35sec/103°	37sec/96°	40sec/90°				
B= 22cm	29sec/93°	33sec/99°	33sec/103°	34sec/106°	37sec/95°	38sec/90°					
B= 24cm	32sec/93°	34sec/99°	36sec/102°	37sec/93°							
B= 26cm	34sec/93°	36sec/98°	37sec/92°								
B= 35cm	38sec/93°										

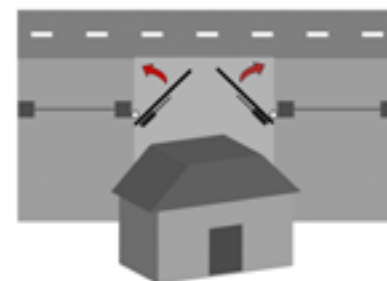

### PUSH TO OPEN OPERATION (opens towards outside)

If your driveway slopes up after the gate, preventing it from swinging in. This means the gate operator is mounted on the inside of the property and pushes your gate out away from the property. Warning:remember to reverse the polarity of the motor cables when connecting to the electronic board

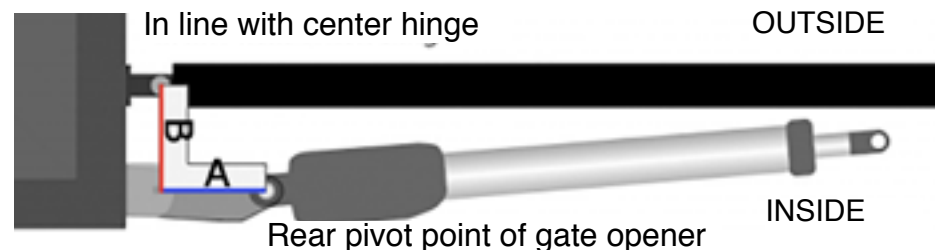

A = min. 8cm  
 B = min. 8cm max. 14cm